



INTERNATIONAL  
**HAKA CLASS**  
ASSOCIATION

**CAMPIONATO ITALIANO**  
coastal rowing & beach sprint  
**Barletta 2021**  
**10/12 settembre**

rowing\_barletta  
Rowing Barletta  
www.cocicoastal2021.it

**Rosito** **SABINO DICATALDO** **UNIWORK** **UNITREND**  
CAFFÈ in sport & costruzioni generali

**Partner** **Media Partner**  
**innex** **V.M.A.** **DINAC** **PUGLIA VILLAGE** **Rai Sport**

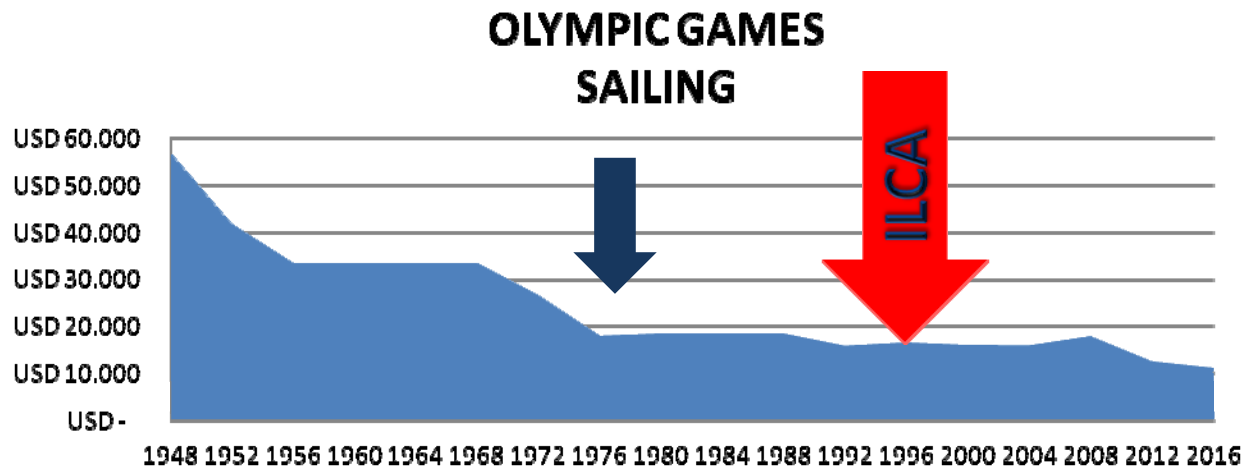



## Object

The boat is a strict one-design dinghy where the true test, when raced, is between helmspersons and not boats and equipment.

## Fundamental Rule

The boat shall be raced in accordance with these Rules, with only **the hull**, equipment, fittings, spars, sail and battens manufactured by a **World Sailing and International Laser Class Association (ILCA) approved builder** in strict adherence to the design specification (known as the Construction Manual) which is registered with World Sailing.





# ILCA Member Districts 2021



**KEY**  
● ILCA ACTIVE DISTRICT

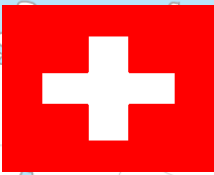
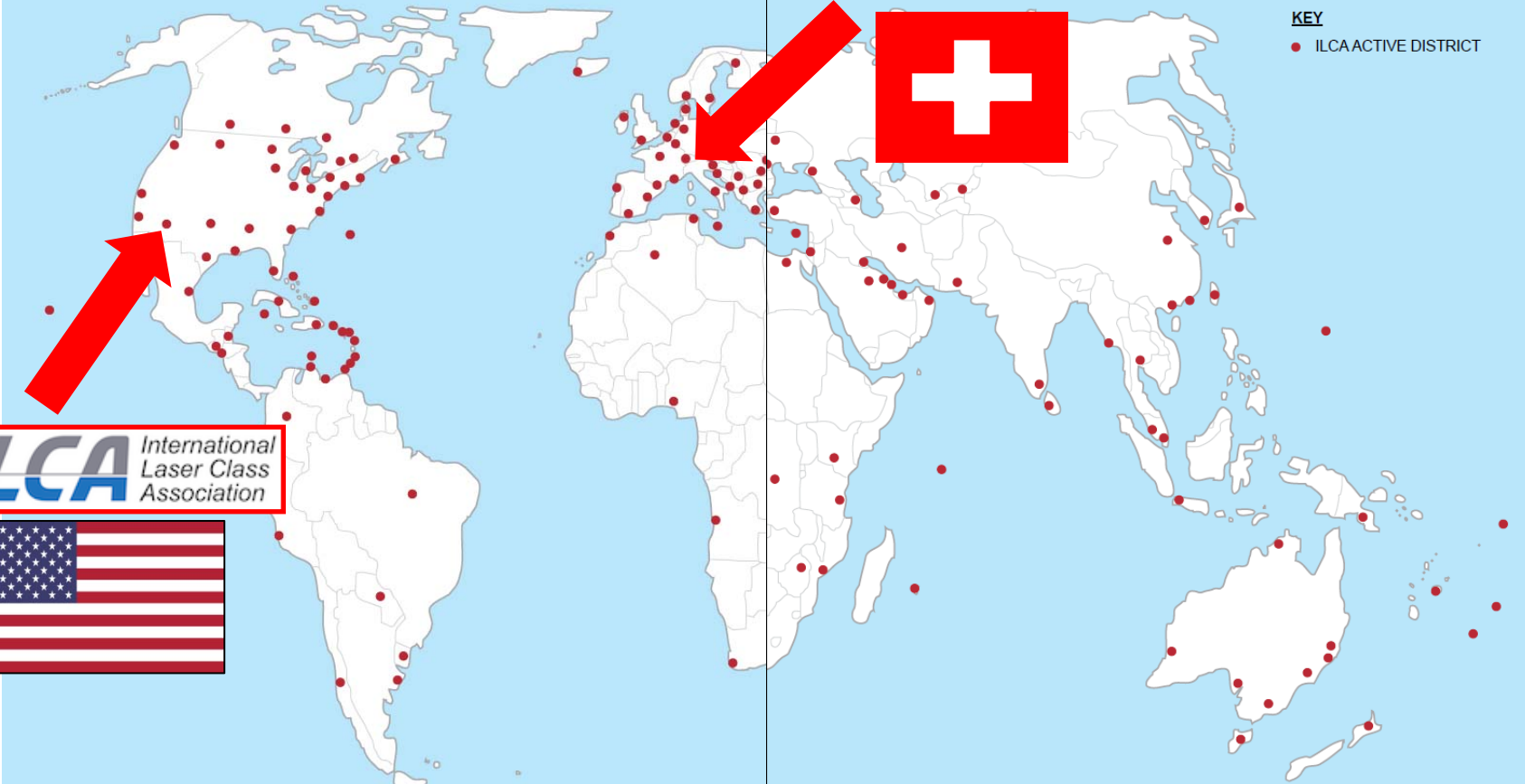

ALGERIA  
AMERICAN SAMOA  
ANDORRA  
ANGOLA  
ANTIGUA  
ARGENTINA  
ARUBA  
AUSTRALIA  
AUSTRIA  
AZERBAIJAN  
BAHAMAS  
BAHRAIN  
BARBADOS  
BELARUS

BELGIUM  
BERMUDA  
BRAZIL  
BRITISH VIRGIN ISLANDS  
BULGARIA  
CAYMAN ISLANDS  
CHILE  
CHINA  
CHINESE TAIPEI  
COLOMBIA  
CROATIA  
CUBA  
CYPRUS

CZECH REPUBLIC  
DENMARK  
DOMINICAN REPUBLIC  
ECUADOR  
EGYPT  
EL SALVADOR  
ESTONIA  
FIJI  
FINLAND  
FRANCE  
GERMANY  
GIBRALTAR  
GREECE  
GUAM

GUATEMALA  
HONG KONG  
HUNGARY  
ICELAND  
INDIA  
INDONESIA  
IRAN  
IRELAND  
ISRAEL  
ITALY  
JAPAN  
KAZAKHSTAN  
KENYA  
KOREA

KUWAIT  
LATVIA  
LITHUANIA  
LUXEMBOURG  
MACAU  
MALAYSIA  
MALTA  
MAURITIUS  
MEXICO  
MOLDOVA  
MONACO  
MONTENEGRO  
MOZAMBIQUE  
MYANMAR

NETHERLANDS  
NETHERLANDS ANTILLES  
NEW ZEALAND  
NIGERIA  
NORTH AMERICA  
NORWAY  
OMAN  
PAKISTAN  
PARAGUAY  
PERU  
POLAND  
PORTUGAL  
PUERTO RICO  
QATAR

ROMANIA  
RUSSIA  
SAMOA  
SERBIA  
SEYCHELLES  
SINGAPORE  
SLOVAKIA  
SLOVENIA  
SOUTH AFRICA  
SPAIN  
ST LUCIA  
SWEDEN  
TAHITI  
TANZANIA

THAILAND  
TRINIDAD & TOBAGO  
TUNISIA  
TURKEY  
TURKS & CAICOS  
UGANDA  
UKRAINE  
UNITED ARAB EMIRATES  
UNITED KINGDOM  
URUGUAY  
US VIRGIN ISLES  
VENEZUELA

### 4.7 Rig

SAIL AREA: 4.70m<sup>2</sup>



### Radial Rig

SAIL AREA: 5.76m<sup>2</sup>



### Standard Rig

SAIL AREA: 7.06m<sup>2</sup>

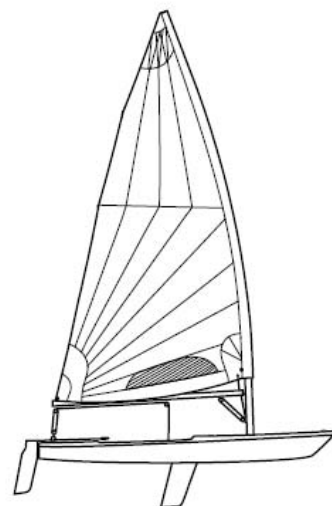

### COASTAL ROWING HAKA™ MONOTYPE

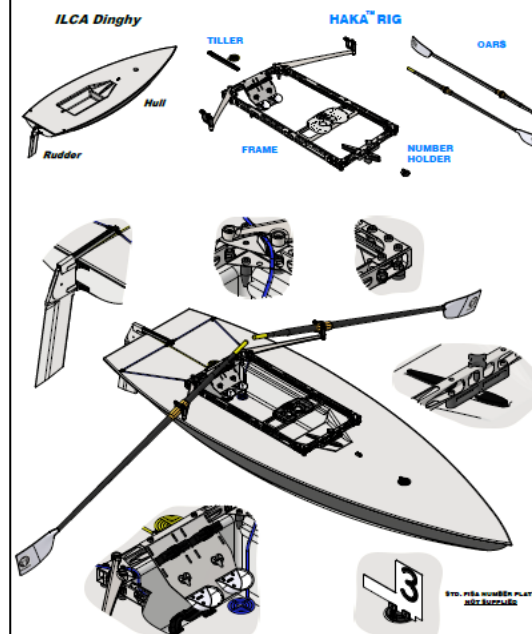

Laser: European Porto 2019 © nauza aires pereira



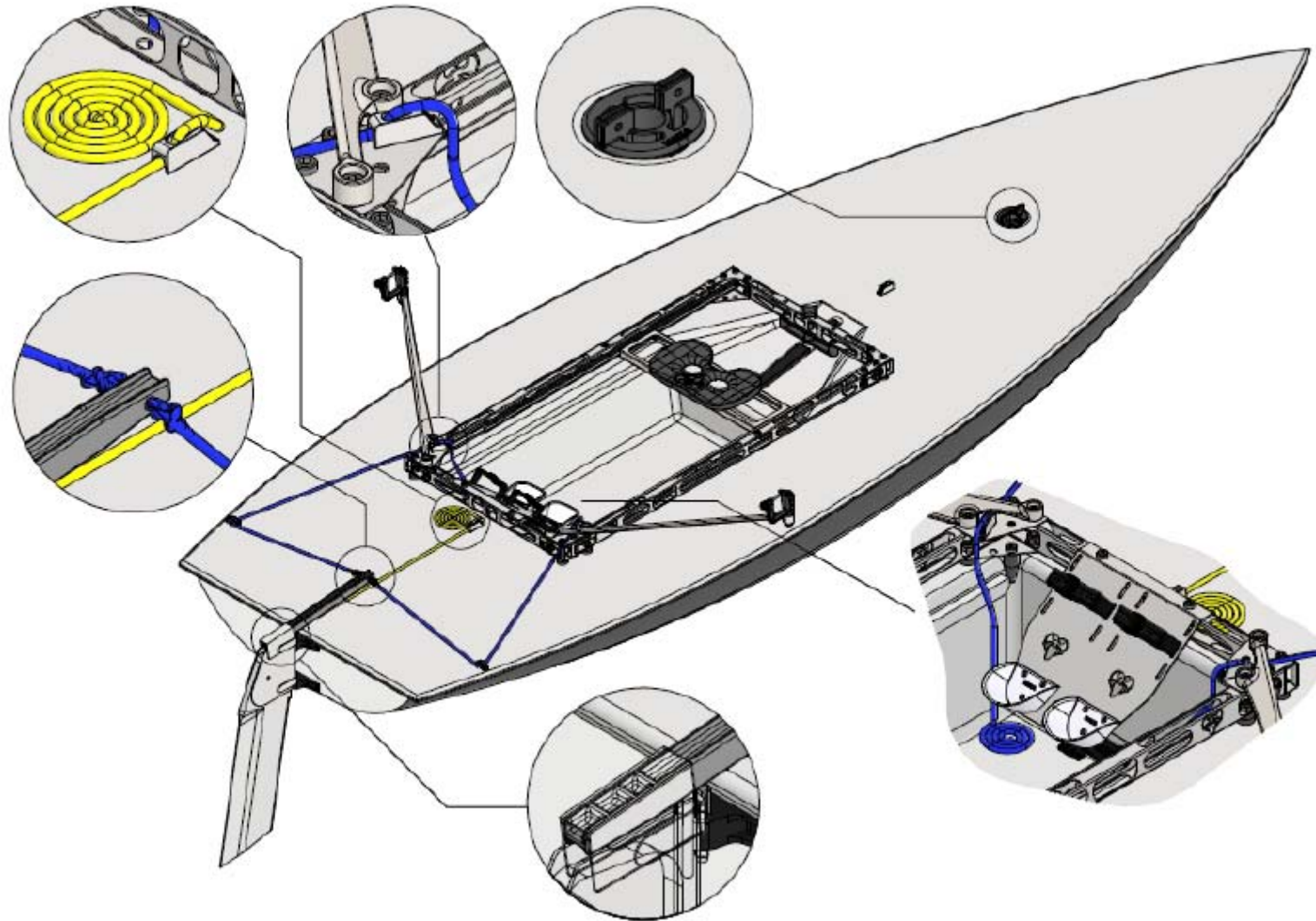



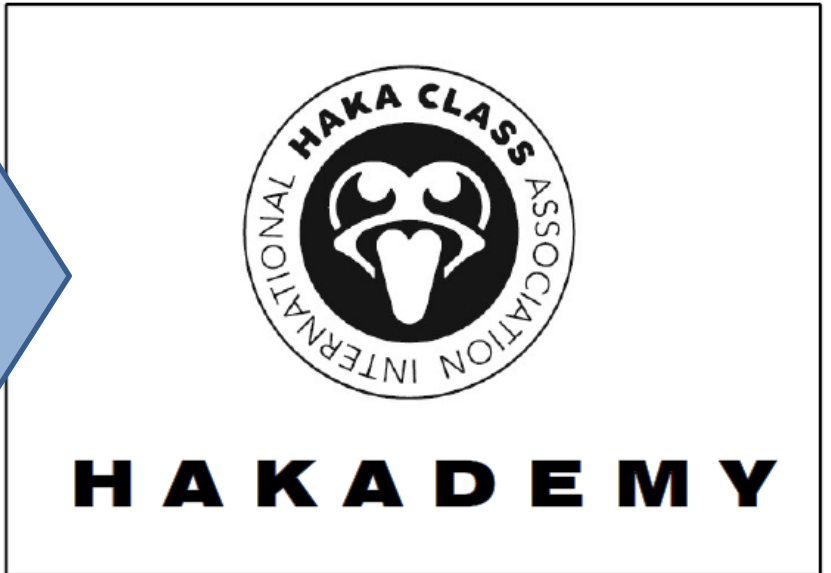
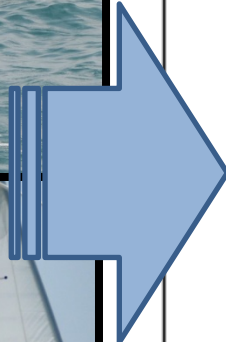



## COASTAL ROWING HAKA™ MONOTYPE

### HAKA™ RIG STORAGE



4 SLOTS

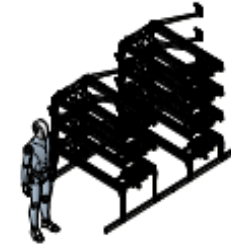
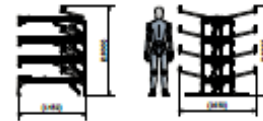

7 SLOTS (4+3)

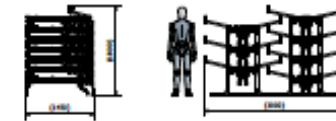

10 SLOTS (3+4+3)

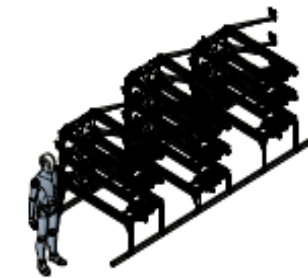
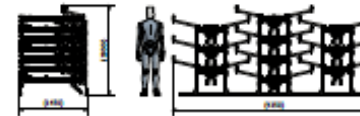

20 SLOTS (10x2)

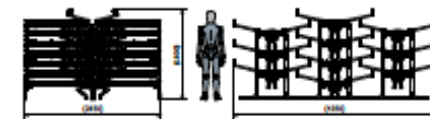
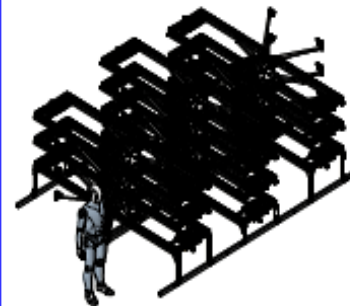



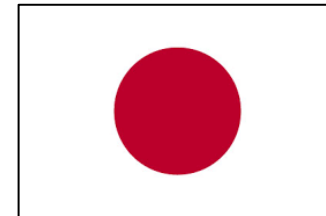
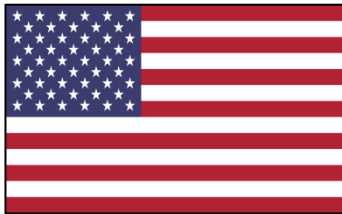

**Sailing & Rowing  
schools**



**Races  
participants > 400**



**Sailing – Rowing  
camps**



**Freedom  
Low cost**



**Seamanship**



**Social rowing**







Grazie ed arrivederci !